

**DISPLAY Elektronik GmbH**

**DATA SHEET**

**LCD MODULE**

**DEM 20121 SYH-LY**

*Product Specification*

*Version : 4.1.2*

**08.01.2018**

# GENERAL SPECIFICATION

---

MODULE NO. :

## DEM 20121 SYH-LY

CUSTOMER P/N

VERSION NO.	CHANGE DESCRIPTION	DATE
0	ORIGINAL VERSION	17.05.2003
1	CHANGE PIN 15&16	29.05.2003
2	CHANGE PCB	05.06.2003
3	CHANGE DRIVING SCHEME	10.06.2003
4	CHANGE BACKLIGHT CURRENT	08.09.2006
4.1.1	CHANGE LCD-DRIVER	13.06.2008
4.1.2	CHANGE MAXIMUM PARAMETER	08.01.2018

PREPARED BY: XYP

DATE: 08.01.2018

APPROVED BY: MH

DATE: 08.01.2018

**CONTENTS**

**1. FUNCTIONS & FEATURES ..... 4**

**2. MECHANICAL SPECIFICATIONS..... 4**

**3. EXTERNAL DIMENSIONS..... 5**

**4. BLOCK DIAGRAM ..... 6**

**5. PIN ASSIGNMENT ..... 6**

**6. PCB DRAWING AND DESCRIPTION..... 7**

**7. BACKLIGHT ELECTRICAL/OPTION CHARATERISTICS..... 8**

**8. MAXIMUM ABSOLUTE POWER RATINGS ( TA=25°C)..... 8**

**9. ELECTRICAL CHARACTERISTICS..... 9**

**10. CONTROL AND DISPLAY COMMAND..... 11**

**11. STANDARD CHARACTER PATTERN (ST7066-0A)..... 12**

**12. LCM INITIALIZATION ..... 13**

**13. LCD MODULES HANDLING PRECAUTIONS..... 17**

**14. OTHERS ..... 17**

**1. FUNCTIONS & FEATURES**

MODULE NAME	LCD TYPE
DEM 20121 SYH-LY	STN Green Transflective Positive Mode

- Viewing Direction : 6 O'clock
- Driving Scheme : 1/8 Duty Cycle, 1/4 Bias
- Power Supply Voltage : 5.0 Volt (typ.)
- Backlight : LED, Yellow Green, Lightbox
- V<sub>LCD</sub> Adjustable For Best Contrast : 4.5 Volt (typ.)
- Display Format : 20 x 1 Characters
- Operation temperature : -20°C to +70°C
- Storage temperature : -30°C to +80°C
- LCD-Driver : ST7066 (Sitronix)
- Internal Memory : CGROM (13200 Bits)  
: CGRAM (64 x 8 Bits )  
: DDRAM (80 x 8 Bits )
- Interface : Easy Interface with 4-Bit or 8-Bit MPU

**2. MECHANICAL SPECIFICATIONS**

- Module Size : 182.00 x 33.50 x 14.50 mm
- Character Pitch : 7.40 x 10.20 mm
- Character Size : 6.70 x 9.40 mm
- Character Font : 5 x 7 dots + cursor line
- Dot Size : 1.30 x 1.30 mm
- Dot Pitch : 1.35 x 1.35 mm

3. EXTERNAL DIMENSIONS

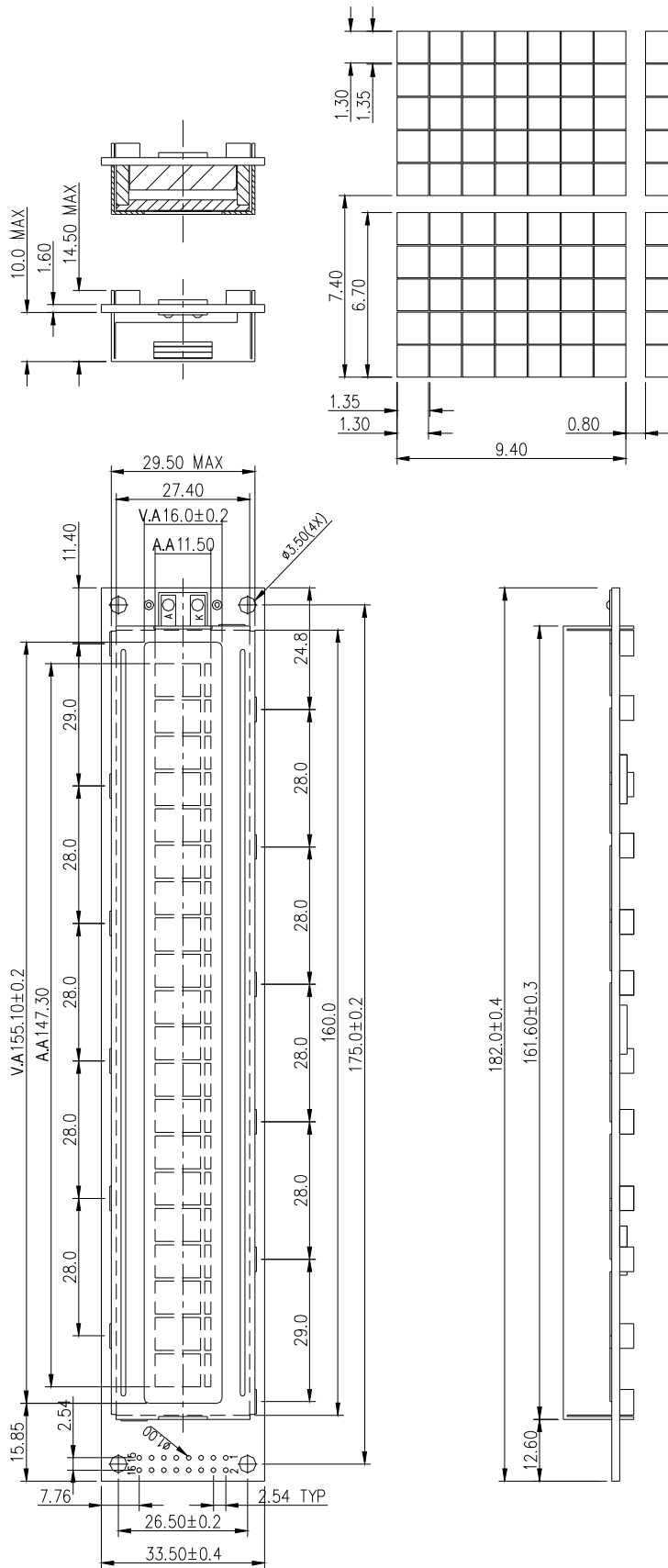

SCALE 5:1

REMARKS:  
1. UNMARKED TOLERANCE IS  $\pm 0.3$ ;  
2. ALL MATERIAL COMPLY WITH ROHS.

4. BLOCK DIAGRAM

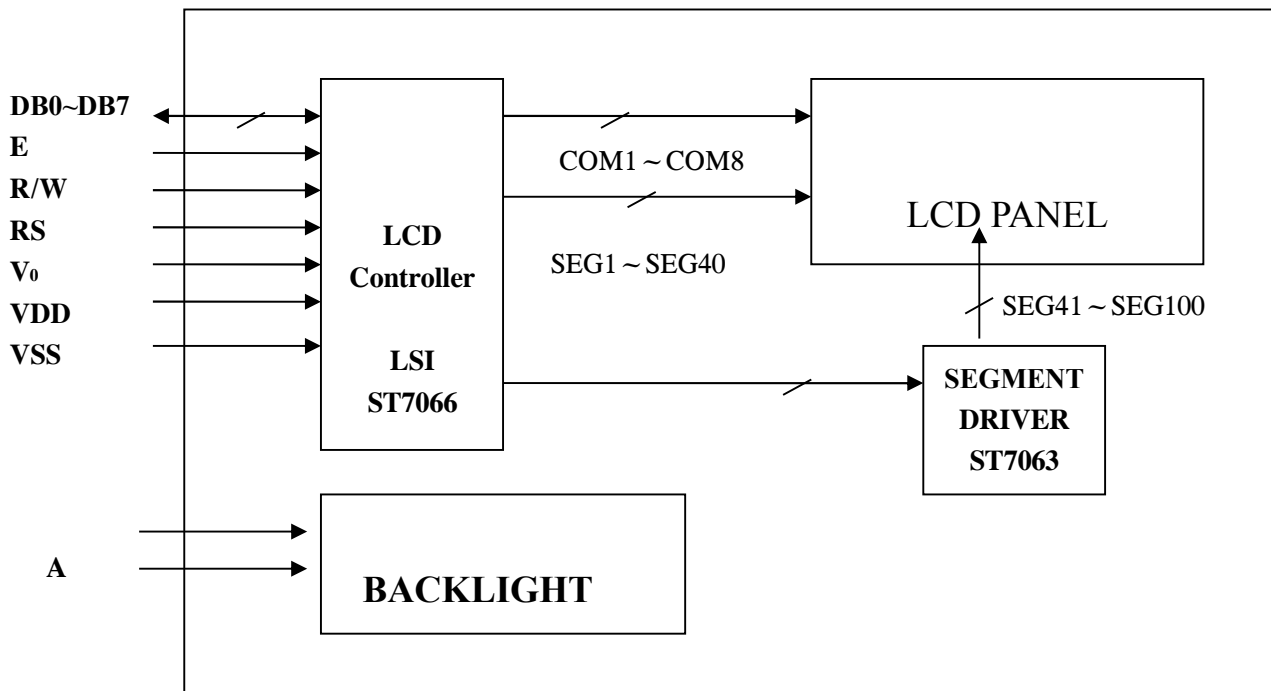

5. PIN ASSIGNMENT

Pin No.	Symbol	Function
1	V <sub>SS</sub>	Ground terminal of module.
2	V <sub>DD</sub>	Power terminal of module 5.0V.
3	V <sub>0</sub>	Power Supply for liquid crystal drive.
4	RS	Register select RS = 0 (Instruction register) RS = 1 (Data register)
5	R/W	Read /Write R/W = 1 (Read) R/W = 0 (Write)
6	E	Read/Write Enable Signal
7	DB0	Bi-directional data bus, data transfer is performed once, thru DB0 to DB7, in the case of interface data. Length is 8-bits; and twice, thru DB4 to DB7 in the case of interface data length is 4-bits. Upper four bits first then lower four bits.
8	DB1	
9	DB2	
10	DB3	
11	DB4	
12	DB5	
13	DB6	
14	DB7	
15	LED - (K)	Please also refer to 6.1 PCB drawing and description.
16	LED + (A)	

6. PCB DRAWING AND DESCRIPTION

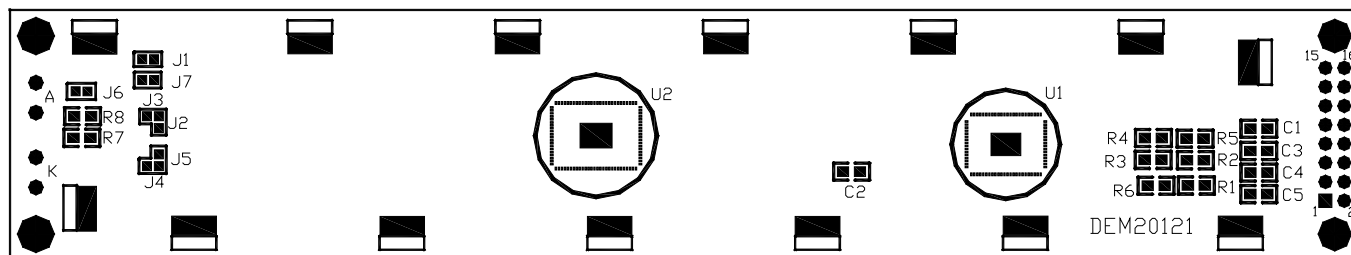

DESCRIPTION:

6-1-1. The polarity of the pin 15 and the pin 16:

J3,J5	J2,J4	LED Polarity	
		15 Pin	16 Pin
Each open	Each closed	Anode	Cathode
Each closed	Each open	Cathode	Anode

Note: In application module, J3=J5=closed and J2=J4=open

6-1-2. The metal-bezel is set be ground when the J1 is closed

Note: In application module, J1=closed

6-1-3. The LED resistor should be bridged when the J6 is open

Note: In application module, J6=open

6-1-4. The mounting-hole is set be ground when the J7 is closed

Note: In application module, J7=closed

6-1-5. The R7 and the R8 are the LED resistor.

Note: In application module, R7=6.8 Ohm and R8=5.6 Ohm.

7. BACKLIGHT ELECTRICAL/OPTION CHARATERISTICS

Item	Symbol	MIN.	TYP.	MAX.	Unit	Condition
Forward Voltage	Vf	3.9	4.1	4.3	V	If= 260 mA
Forward Current	If				mA	
Power Dissipation	Pd		1.68		W	
Reverse Voltage	VR		10.0		V	
Reverse Current	IR			0.26	mA	Vr=10V
Luminous Intensity	Iv	160	180		cd/m <sup>2</sup>	If= 260 mA
Luminous Uniformity	ΔL		80		%	If= 260 mA
Emission Wavelength	λP	569	572	575	nm	If= 260 mA
Spectral Range	Δλ		30			Ta= 25°C

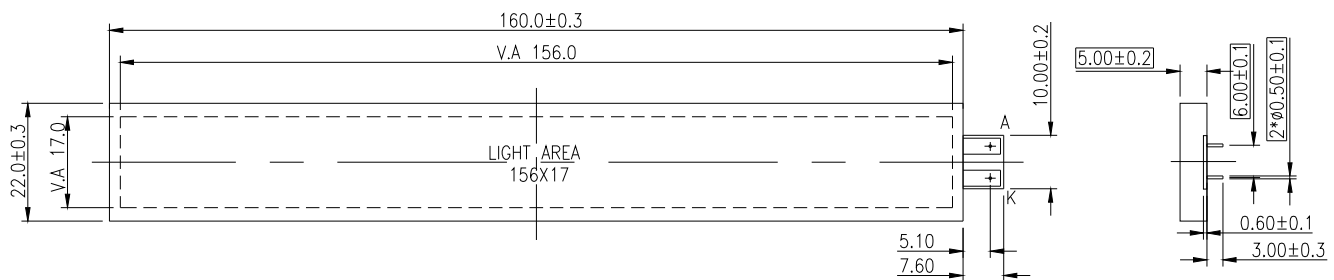

REMARKS:  
 1.UNMARKED TOLERANCE IS ±0.3  
 2.ALL MATERIALS COMPLY WITH ROHS.  
 3.COLOR:YELLOW-GREEN.

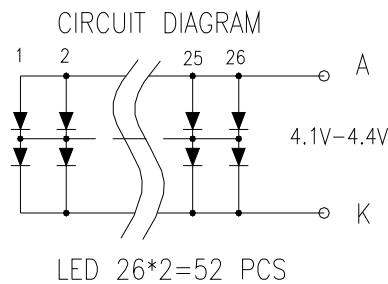

8. MAXIMUM ABSOLUTE POWER RATINGS (Ta=25°C)

Item	Symbol	Standard value	Unit
Power Supply Voltage (1)	V <sub>DD</sub>	-0.3 ~ +6.0	V
Power Supply Voltage (2)	V <sub>0</sub>	V <sub>DD</sub> -10.0 ~ V <sub>DD</sub> +0.3	V
Input Voltage	V <sub>IN</sub>	-0.3 ~ V <sub>DD</sub> +0.3	V
Operating Temperature	T <sub>opr</sub>	-20 ~ +70	°C
Storage Temperature	T <sub>stg</sub>	-30 ~ +80	°C



9. ELECTRICAL CHARACTERISTICS

9-1 DC Characteristics ( $V_{DD}=5V$ ,  $T_a=-20\sim+70^{\circ}C$ )

Item	Symbol	Standard Value			Test Condition	Unit
		MIN	TYP	MAX		
Operating Voltage	$V_{DD}$	4.7	5	5.3	-----	V
Consumed Current	$I_{DD}$	----	TBD	----		mA
LCD Driving Voltage	$V_{LCD}$	3.0	4.5	7.0	$V_{DD}-V_5$ (1/5,1/4 Bias)	V

9-2. AC Characteristics ( $V_{DD}=5V$ ,  $T_a=-20\sim+70^{\circ}C$ )

9 -2-1 Write Mode (Writing Data from MPU to ST7066)

Characteristic	Symbol	Min	Type	Max	Unit	Test PIN
E Cycle Time	$t_c$	1200	---	---	ns	E
E Rise Time	$t_r$	---	---	25	ns	E
E Fall Time	$t_f$	---	---	25	ns	E
E Pulse width (High,Low)	$t_{pw}$	140	---	---	ns	E
R/W and RS Set-up Time	$t_{AS}$	0	---	---	ns	R/W,RS,E
R/W and RS Hold Time	$t_{AH}$	10	---	---	ns	R/W,RS,E
Data Set-up Time	$t_{DSW}$	40	---	---	ns	DB0~DB7
Data Hold Time	$t_H$	10	---	---	ns	DB0~DB7

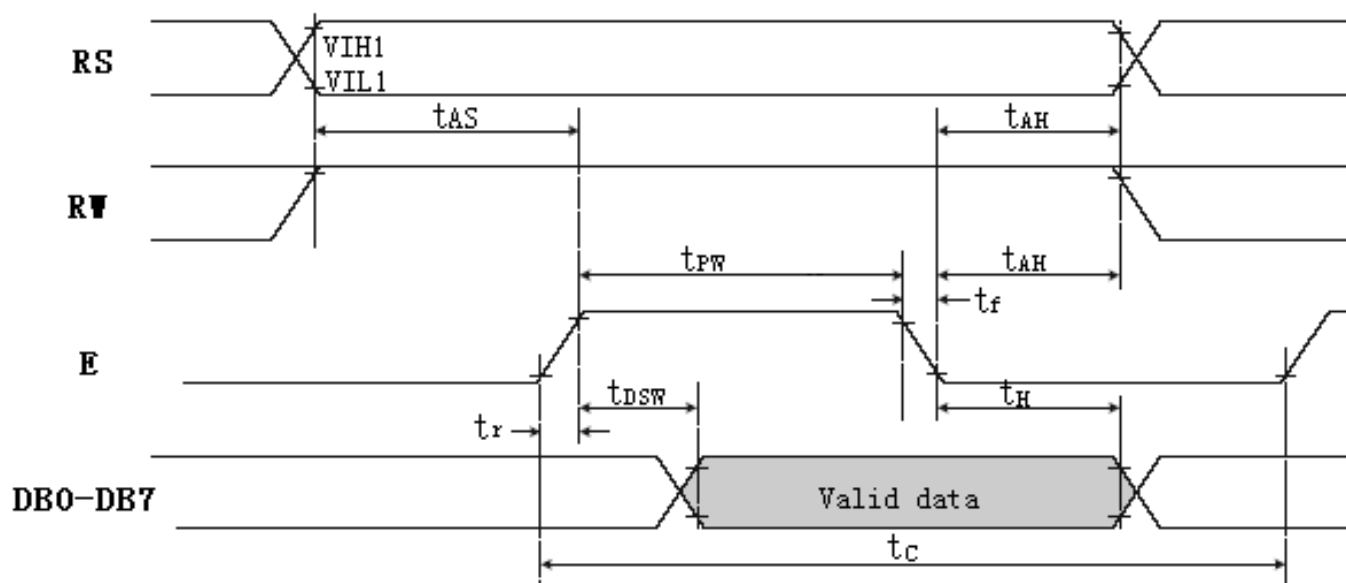

**9-2-2 Read Mode (Reading Data from ST7066 to MPU)**

Characteristic	Symbol	Min	Type	Max	Unit	Test PIN
E Cycle Time	$t_c$	1200	---	---	ns	E
E Rise Time	$t_r$	---	---	25	ns	E
E Fall Time	$t_f$	---	---	25	ns	E
E Pulse width (High, Low)	$t_{PW}$	140	---	---	ns	E
R/W and RS Set-up Time	$t_{AS}$	0	---	---	ns	R/W,RS
R/W and RS Hold Time	$t_{AH}$	10	---	---	ns	R/W,RS
Data Setup Time	$t_{DDR}$	---	---	100	ns	DB0~DB7
Data Hold Time	$t_H$	10	---	---	ns	DB0~DB7

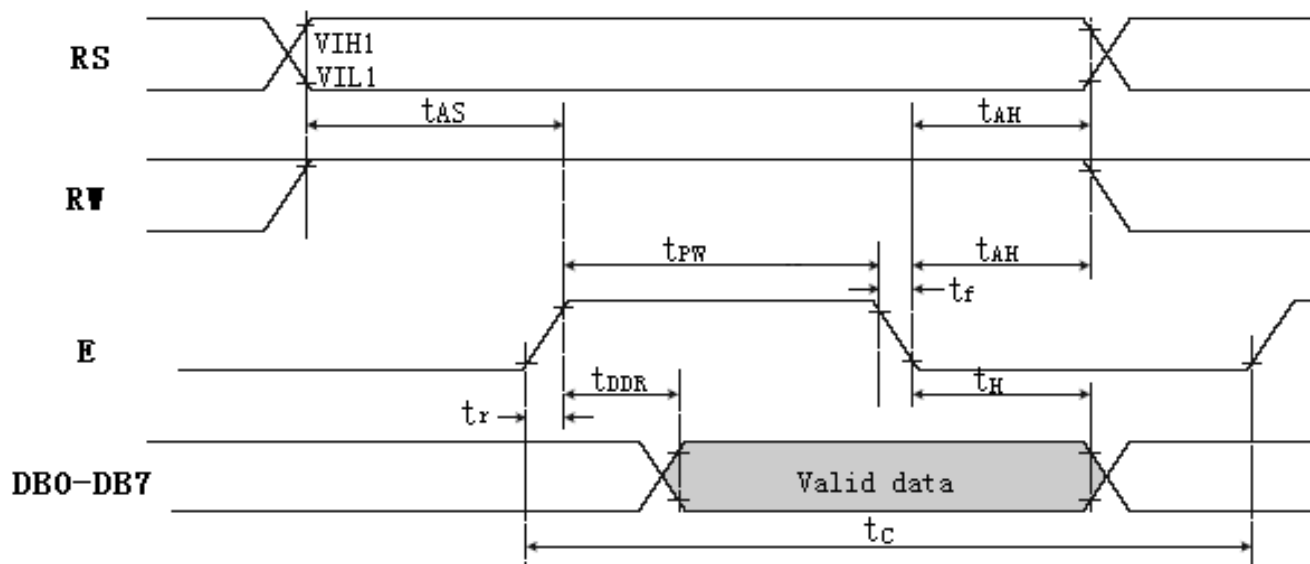

## 10. CONTROL AND DISPLAY COMMAND

Instruction	Instruction Code										Description	Description Time (270KHz)	
	RS	R/W	DB7	DB6	DB5	DB4	DB3	DB2	DB1	DB0			
<b>Clear Display</b>	0	0	0	0	0	0	0	0	0	0	1	Write "20H" to DDRAM. and set DDRAM address to "00H" from AC	1.52 ms
<b>Return Home</b>	0	0	0	0	0	0	0	0	0	1	X	Set DDRAM address to "00H" from AC and return cursor to its original position if shifted. The contents of DDRAM are not changed.	1.52 ms
<b>Entry Mode Set</b>	0	0	0	0	0	0	0	0	1	I/D	S	Sets cursor move direction and specifies display shift. These operations are performed during data write and read.	37 us
<b>Display ON/OFF</b>	0	0	0	0	0	0	0	1	D	C	B	D=1:entire display on C=1:cursor on B=1:cursor position on	37 us
<b>Cursor or Display Shift</b>	0	0	0	0	0	0	1	S/C	R/L	X	X	Set cursor moving and display shift control bit, and the direction, without changing DDRAM data.	37 us
<b>Function Set</b>	0	0	0	0	0	1	DL	N	F	X	X	DL:interface data is 8/4 bits N:number of line is 2/1 F:font size is 5x1/5x8	37 us
<b>Set CGRAM address</b>	0	0	0	1	AC5	AC4	AC3	AC2	AC1	AC0		Set CGRAM address in address counter	37 us
<b>Set DDRAM address</b>	0	0	1	AC6	AC5	AC4	AC3	AC2	AC1	AC0		Set DDRAM address in address counter	37 us
<b>Read Busy flag and address</b>	0	1	BF	AC6	AC5	AC4	AC3	AC2	AC1	AC0		Whether during internal operation or not can be known by reading BF. The contents of address counter can also be read.	0 us
<b>Write data to RAM</b>	1	0	D7	D6	D5	D4	D3	D2	D1	D0		Write data into internal RAM (DDRAM/CGRAM)	37 us
<b>Read data from RAM</b>	1	1	D7	D6	D5	D4	D3	D2	D1	D0		Read data from internal RAM (DDRAM/CGRAM)	37 us

Note:

Be sure the ST7066U is not in the busy state (BF = 0) before sending an instruction from the MPU to the ST7066U. If an instruction is sent without checking the busy flag, the time between the first instruction and next instruction will take much longer than the instruction time itself. Refer to Instruction Table for the list of each instruction execution time.

11. STANDARD CHARACTER PATTERN (ST7066-0A)

NO.7066-0A

b7-b4 b3-b0	0000	0001	0010	0011	0100	0101	0110	0111	1000	1001	1010	1011	1100	1101	1110	1111
0000	CG RAM (1)			0	1	2	3	4				5	6	7	8	9
0001	(2)		!	1	A	Q	a	A			.	7	7	4	3	q
0010	(3)		"	2	B	R	b	r			7	4	9	×	P	0
0011	(4)		#	3	C	S	c	s			7	0	7	E	E	0
0100	(5)		*	4	D	T	d	t			\	1	1	P	H	0
0101	(6)		%	5	E	U	e	u			*	7	7	1	0	0
0110	(7)		&	6	F	V	f	v			7	0	2	0	P	Z
0111	(8)		'	7	G	W	g	w			7	7	7	7	g	W
1000	(1)		<	8	H	X	h	x			4	0	*	U	J	X
1001	(2)		>	9	I	Y	i	y			0	7	U	U	U	U
1010	(3)		*	:	J	Z	j	z			2	0	0	U	J	7
1011	(4)		+	;	K	L	k	l			*	7	0	0	0	W
1100	(5)		,	<	L	;	l	l			7	0	0	0	0	W
1101	(6)		-	=	M	?	m	?			2	7	0	0	0	7
1110	(7)		.	>	N	^	n	^			0	0	0	0	0	0
1111	(8)		/	?	O	_	o	*			0	0	0	0	0	0

12. LCM INITIALIZATION

- 8-bit Interface (fosc=270KHz)

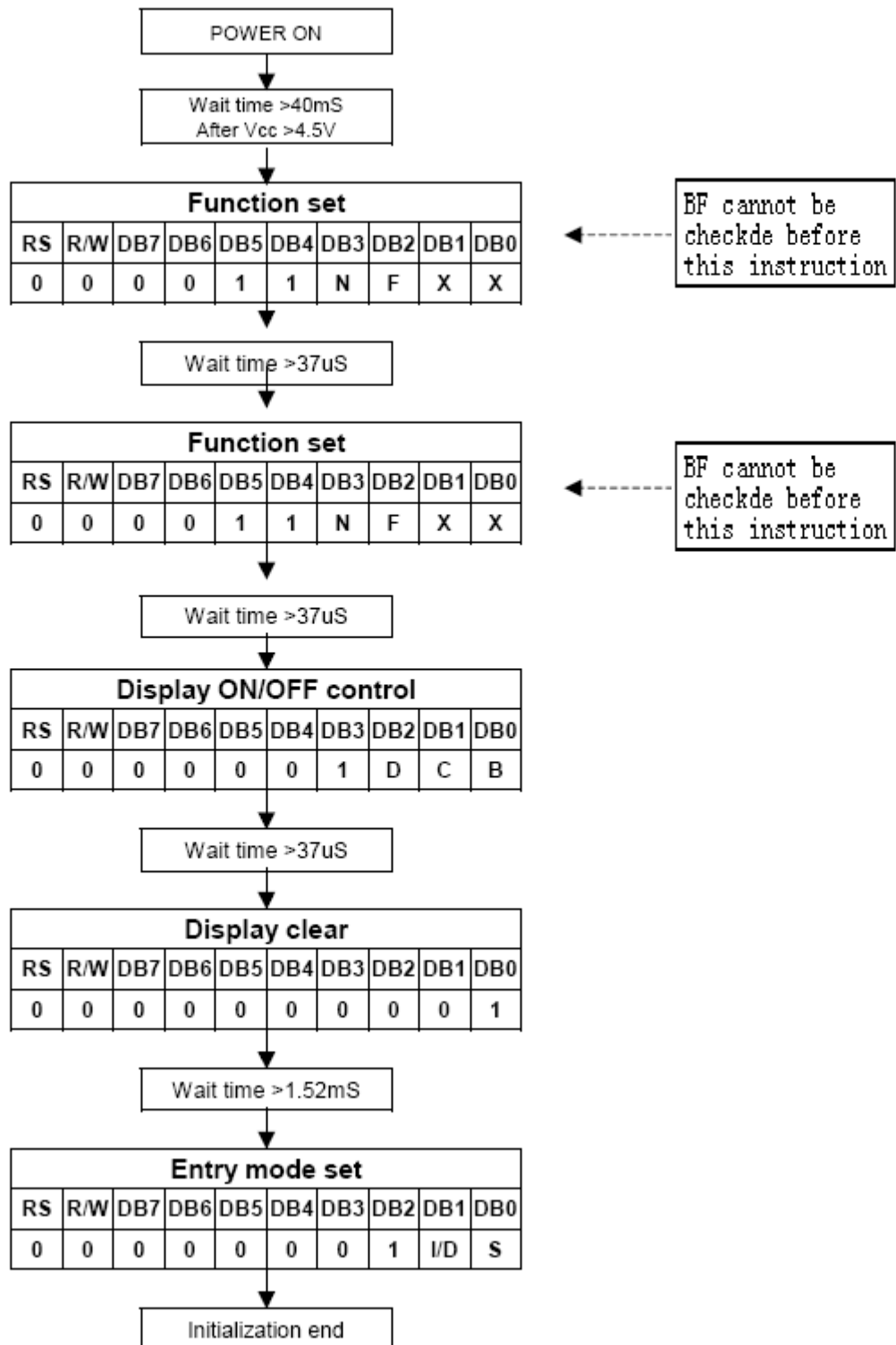

● 4-bit Interface (fosc=270KHz)

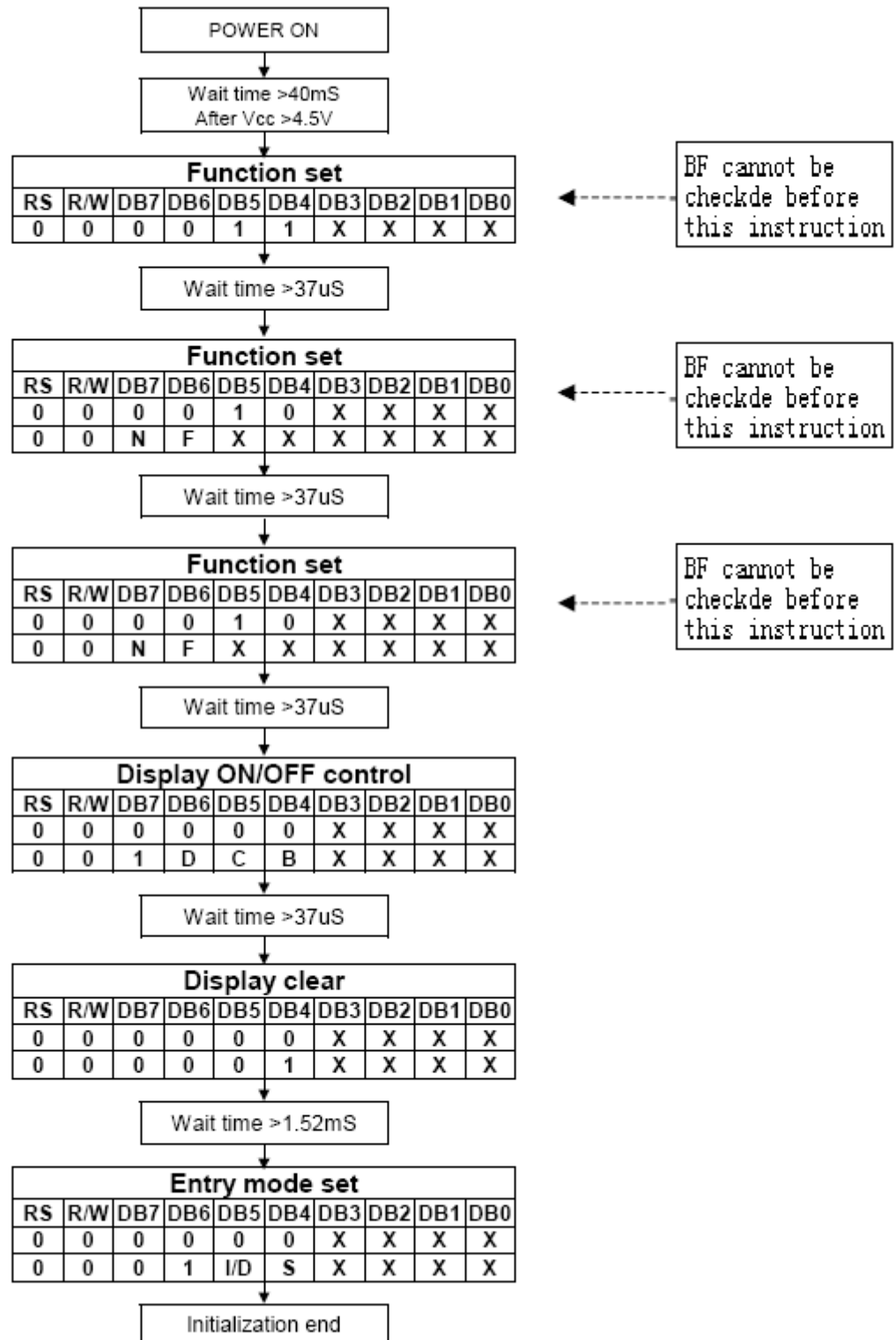

13. QUALITY DESCRIPTION

DEFECT SPECIFICATION:

Specific type-related items are covered in this sheet.

- a: Table for Cosmetic defects  
(Note: nc = not counted).  
Sizes and number of defects  
(Max. Qty)

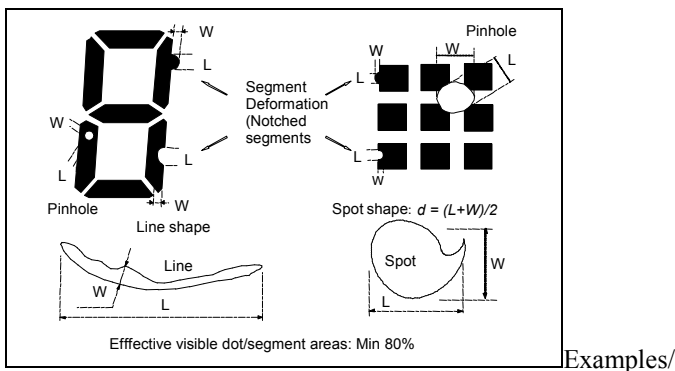

Shapes

- b: Glass defects
- b1: Glass defects at contact ledge

Defect Type	Max. defect size [ $\mu\text{m}$ ] d or L	W	Max. Quantity.
Black or White Spots	$d \leq 150$		nc
	$150 < d \leq 300$		5
Black or White Lines	--	$W \leq 10$	nc
	$L \leq 5000$	$W \leq 30$	3
	$L \leq 2000$	$W \leq 50$	2
Pinhole	$d \leq 100$		nc
	$150 < d \leq 300$		1/segment
(Total defects)			(5)
Segment Deformation		$W \leq 100$	nc
Bubble (e.g. under pola)	$d \leq 150$		nc
	$200 < d \leq 400$		3
	$400 < d \leq 600$		1

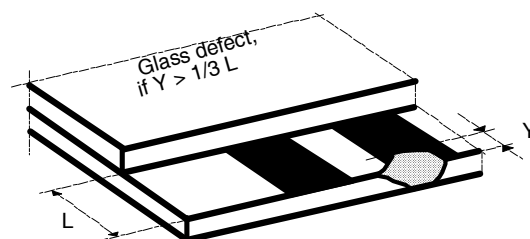

b2: Glass chipping in other areas shall not be in conflict with the product's function.

**14. MODULE ACCEPT QUALITY LEVEL (AQL)**

14.1 AQL Standard Value: Fatal Defect =0.1, Major Defect=0.65; Minor Defect =2.5.

14.2 Curtailed Inspection Scheme

Type	Batch Qty	inspection Qty	AQL value	pass	Reject
module product	350PCS < 1000PCS	125pcs	0.1	0	1
			0.65	2	3
			2.5	7	8
	200PCS < 350PCS	80pcs	0.1	0	1
			0.65	1	2
			2.5	5	6
	<200PCS	32pcs	0.1	0	1
			0.65	0	1
			2.5	4	5
Module sample	<200PCS	All inspected	/	/	The sample will be reject when the fateful defect > 2pcs or main defect > 5pcs.
	>200PCS	125pcs			

- Notes:** 1). Batch QTY is the production amount that Production department ship to QA department.  
 2). All of product will be inspected if the batch QTY less than inspected QTY.  
 3). Each batch fixed to be 500pcs.

**15. RELIABILITY TEST**

Operating life time: Longer than 50000 hours (at room temperature without direct irradiation of sunlight)  
 Reliability characteristics shall meet following requirements.

TEMPERATURE TESTS	NORMAL GRADE
High Temperature Storage	+80°C x 96hrs (Without Polarizer)
Low Temperature Storage	-30°C x 96hrs
High Temperature Operation	+70°C x 96hrs
Low Temperature Operation	-20°C x 96hrs
High Temperature, High Humidity	+70°C x 95%RH x 96hrs (Without Polarizer)
Thermal Shock	-20°C x 30min. 10s ↓ 5Cycles +70°C x 30min.
Vibration Test	Frequency x Swing x Time 40Hz x 4mm x 4hrs
Drop Test	Drop height x Times 1.0m x 6times



**17. LCD MODULES HANDLING PRECAUTIONS**

- Please remove the protection foil of polarizer before using.
- The display panel is made of glass. Do not subject it to a mechanical shock by dropping it from a high place, etc.
- If the display panel is damaged and the liquid crystal substance inside it leaks out, do not get any in your mouth. If the substance come into contact with your skin or clothes promptly wash it off using soap and water.
- Do not apply excessive force to the display surface or the adjoining areas since this may cause the color tone to vary.
- The polarizer covering the display surface of the LCD module is soft and easily scratched. Handle this polarize carefully.
- To prevent destruction of the elements by static electricity, be careful to maintain an optimum work environment.
  - Be sure to ground the body when handling the LCD module.
  - Tools required for assembly, such as soldering irons, must be properly grounded.
  - To reduce the amount of static electricity generated, do not conduct assembly and other work under dry conditions.
  - The LCD module is coated with a film to protect the display surface. Exercise care when peeling off this protective film since static electricity may be generated.
- Storage precautions  
When storing the LCD modules, avoid exposure to direct sunlight or to the light of fluorescent lamps. Keep the modules in bags designed to prevent static electricity charging under low temperature / normal humidity conditions (avoid high temperature / high humidity and low temperatures below 0°C). Whenever possible, the LCD modules should be stored in the same conditions in which they were shipped from our company.

**18. OTHERS**

- Liquid crystals solidify at low temperature (below the storage temperature range) leading to defective orientation of liquid crystal or the generation of air bubbles (black or white). Air bubbles may also be generated if the module is subjected to a strong shock at a low temperature.
- If the LCD modules have been operating for a long time showing the same display patterns may remain on the screen as ghost images and a slight contrast irregularity may also appear. Abnormal operating status can be resumed to be normal condition by suspending use for some time. It should be noted that this phenomena does not adversely affect performance reliability.
- To minimize the performance degradation of the LCD modules resulting from caused by static electricity, etc. exercise care to avoid holding the following sections when handling the modules:
  - Exposed area of the printed circuit board
  - Terminal electrode sections